

# Теория Решения Изобретательских Задач

## **Inventive Problem Solving**

### **Introduction to TRIZ**

Innovation

all innovations emerge from the application of a very small number of inventive principles and strategies.

# Introduction to TRIZ Agenda

<b>Time</b>	<b>Agenda</b>	<b>Owner</b>
0900 – 0945	Module 1: Introduction to TRIZ Methodology & 4 TRIZ Concepts	Instructor
1045 – 1100	Break	All
1100 – 1245	Module 2: 39 System Parameters	Instructor
1245 – 1400	Break	All
1400 – 1530	Module 3: 40 Inventive Principles	Instructor
1530 – 1545	Break	All
1545 – 1630	Module 4: Engineering Contradiction & Contradiction Matrix	Instructor
1630 – 1645	Competency Test	Participants
1645 – 1700	Conclusion & Closing	All

# Introduction to TRIZ Methodology

## **MODULE 1**

# What is TRIZ?

- TRIZ is the Russian acronym for the “Theory of Inventive Problem Solving”.
- It is a systematic problem solving method based on logic and data, not intuition or spontaneous creativity of individuals or groups



- Developed by Genrich Altshuller and his colleagues from 1946 through to 1985 in the former Union of Soviet Socialist Republics (USSR)
- It is based on the study of patterns of problems and solutions
- TRIZ provides repeatability, predictability, and reliability due to its structure and algorithmic approach
- It improves individual or team’s ability to solve problems

# Key Discoveries

Initial analysis of patents (worldwide)

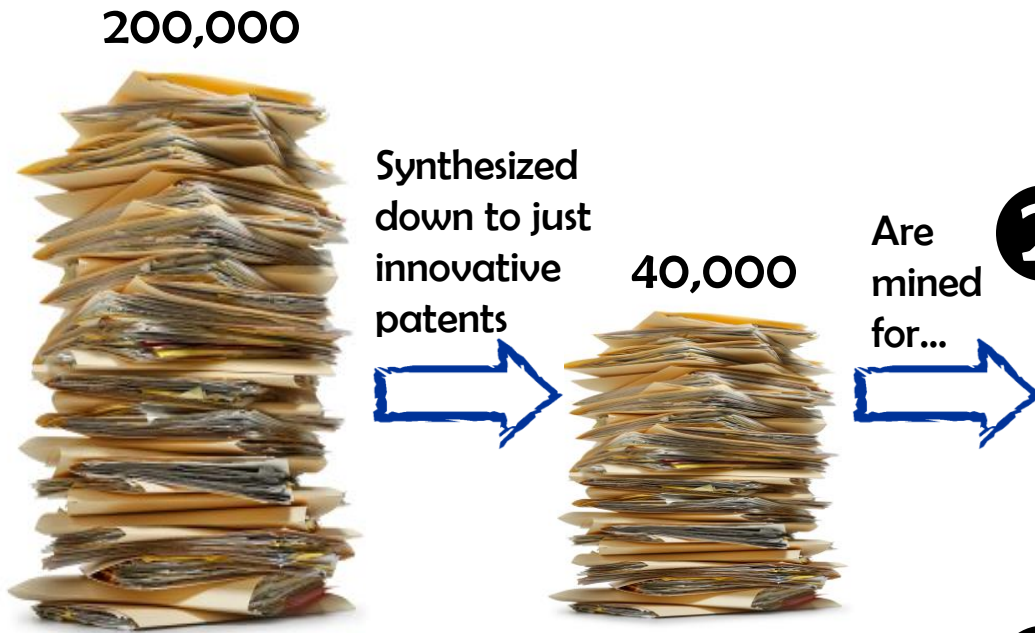

\* Today >2.8M patents have been analyzed & investigated

TRIZ is a statistically based family of principles and strategies enabling engineers to identify potential solution paths of technical problems

- 1 Problems and solutions were repeated across industries & sciences → **40 Inventive Principles for solving Problems**
- 2 Patterns of technical evolution were repeated across industries & sciences → **Technology Trends to evolve a technical system to the next generation**
- 3 Innovations used scientific effects outside the field from where the original problem was found → **Scientific Effects can be used to solve problems in unique ways**

# Why TRIZ?

**Trial and error  
problem solving  
approach**



**Structured and  
systematic problem  
solving approach**

**Increase efficiency and speed of innovation**

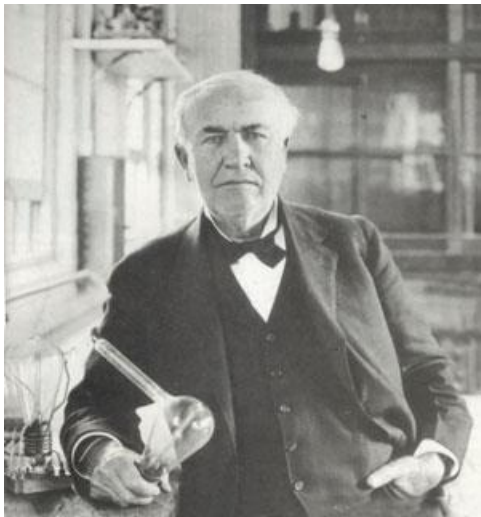

**Thomas Alva Edison (1847 – 1931)**

**“Genius is one percent inspiration, ninety-  
nine percent perspiration”**

**In 1879, after spending \$40,000, and performing 1,200 experiments with 5,000 researchers, Edison succeeded in making a light bulb using carbonized filaments from cotton thread. The light bulb burned for two days. The electric light took the greatest amount of time and required the most complicated experiments of all his experiments.**

# TRIZ Proliferation

methodology embraced by  
many corporations

siemens	intel
samsung	boeing
whirlpool	motorola
lg	procter & gamble
christian dior	delphi automotive

MAY 31, 2006  
INNOVATION  
By Reena Jana

**BusinessWeek**

## The World According to TRIZ

Blue-chip American companies are embracing a 60-year-old innovation theory pioneered by a Russian inventor

Fast-forward to 2006. The list of American companies that have applied Altshuller's recipe for innovation includes Boeing ([BA](#)), Hewlett Packard ([HPQ](#)), IBM ([IBM](#)), Motorola ([MOT](#)), Raytheon ([RTN](#)), and Xerox ([XRX](#)), among others.

**BusinessWeek**

TECHNOLOGY December 25, 2008, 12:01AM EST

text size: T | T

## Tech Innovations for Tough Times

How GE and others are using alternative techniques such as TRIZ to make R&D more efficient

By [Steve Hamm](#)

These days, TRIZ is coming on strong at corporations hungry for new ways to improve innovation and productivity beyond what they've already achieved with the widely adopted Six Sigma and Lean techniques. In addition to GE, TRIZ fans include Intel ([INTC](#)), [Samsung](#), and Procter & Gamble ([PG](#)), as well as smaller companies like FuelCell Energy ([FCEL](#)), a Danbury (Conn.) leader in power-generation fuel cells. The company employed TRIZ to evaluate the expensive flanges it uses to join pipes in its generators. After weighing the component costs, effectiveness, and complexity of assembly, FuelCell switched to a new clamping technique that will slash costs by 50%.

save to del.icio.us

save to del.icio.us

linkedin connections

## A Perpetual Crisis Machine

Samsung's VIP Center is home to a uniquely paranoid culture--and that's the way the boss likes it.

By **PETER LEWIS**  
September 19, 2005

**FORTUNE**

In any event, TRIZ is by no means unique to Samsung; hundreds of companies--including competitors like Philips, LG, and Motorola--use it too. At the VIP Center, however, the goal is to train every engineer and researcher in the company in TRIZ think.

# How does TRIZ work?

Innovative solutions to difficult problems could be found not by probing the nooks and crannies of the right brain but by studying the way others had already attacked similar problems.

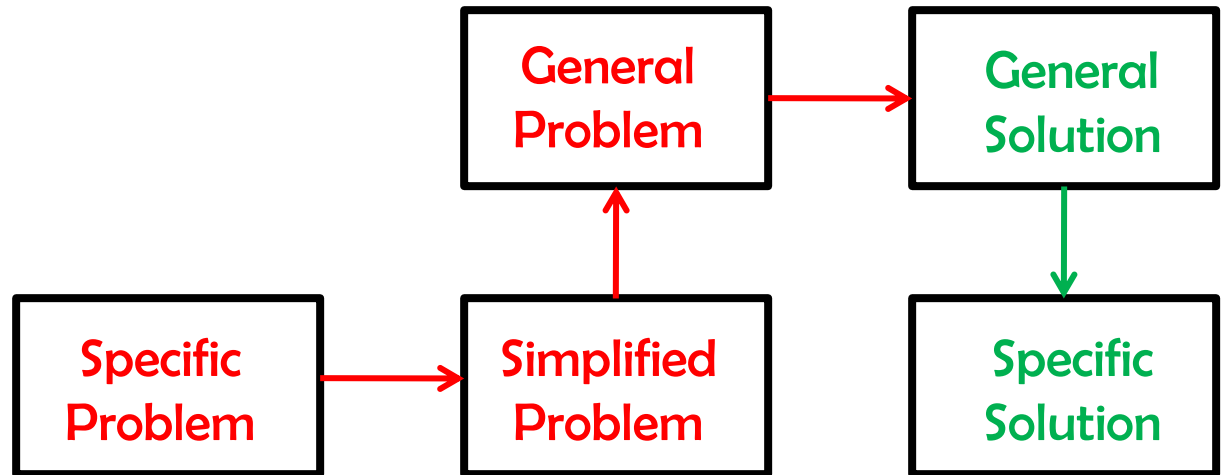



# How do we solve problems?

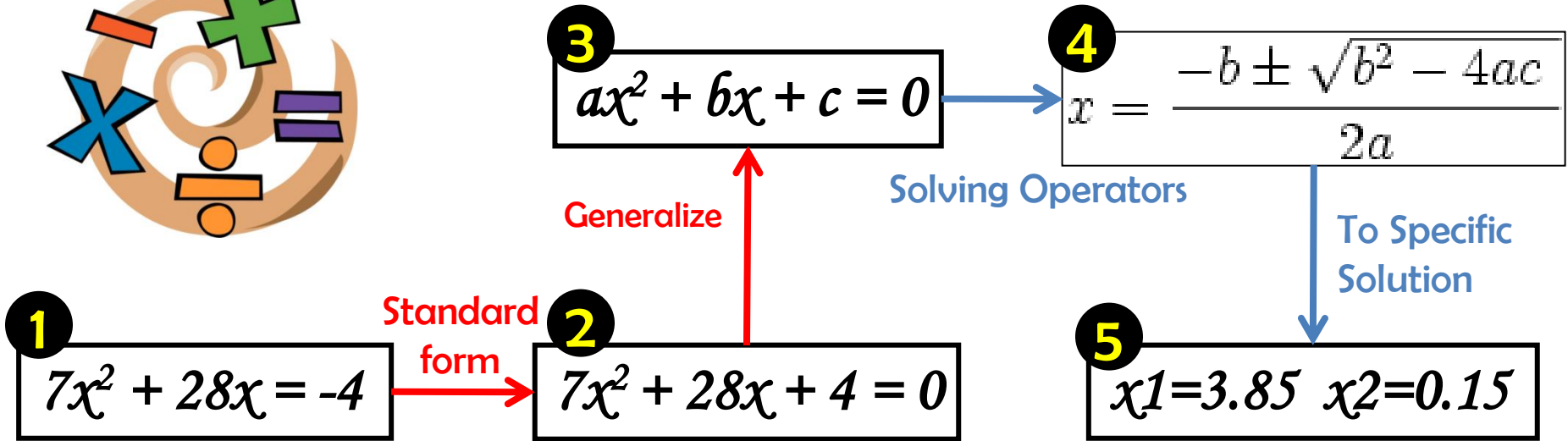
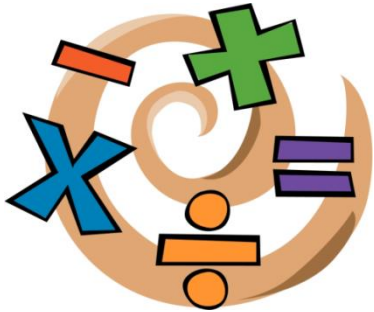

## TRIZ Approach

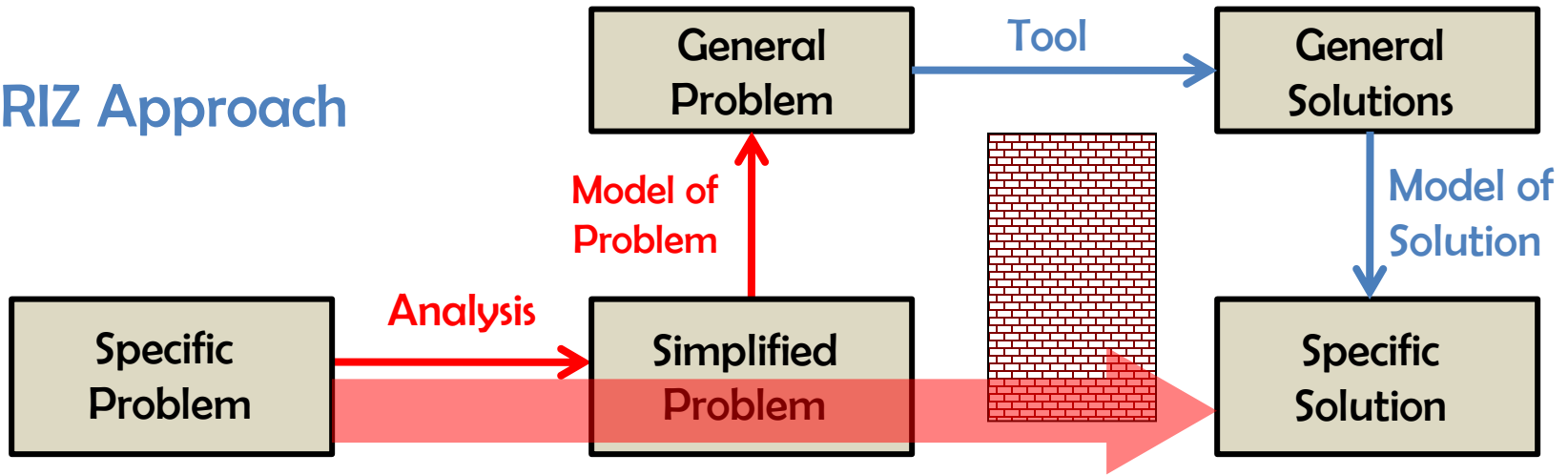

# Usual ways to solve a problem

**Trial and error way**

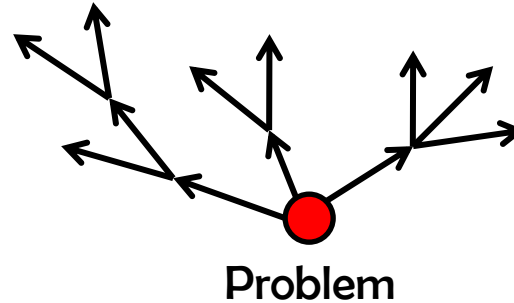

**Structured ways**

Brainstorming  
Trigger Approach  
Checklist  
Morphological Approach  
Synetics  
Etc.

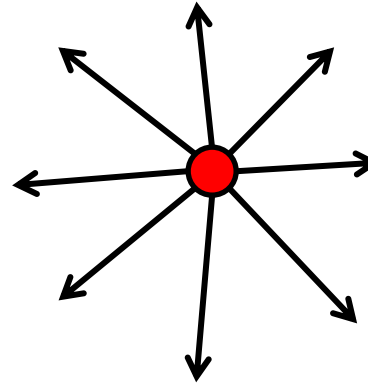

# Limitation of usual problem solving methods

- **Psychological inertia**
- **Lack of knowledge**
- **Wrong objective or goal**
- **Avoid conflict or contradiction**
- **Do not know actual root cause**

# Psychological Inertia - Exercise #1

You are given 2 mosquito coils and 1 box of matches, find the solution on how to get exactly 45 minutes if each coil burns for 1 hour

Mosquito Coil



60 minutes

Mosquito Coil



60 minutes

Matches



# Psychological Inertia - Exercise #2

Given 3 rooms upstairs with 1 wall lamp each which is controlled by 3 light switches in another room which is downstairs.

It is not possible to observe whether the rooms are lighted from the room where the switches are located.

How do you identify which switch is for each room if you are allowed to go upstairs only once?

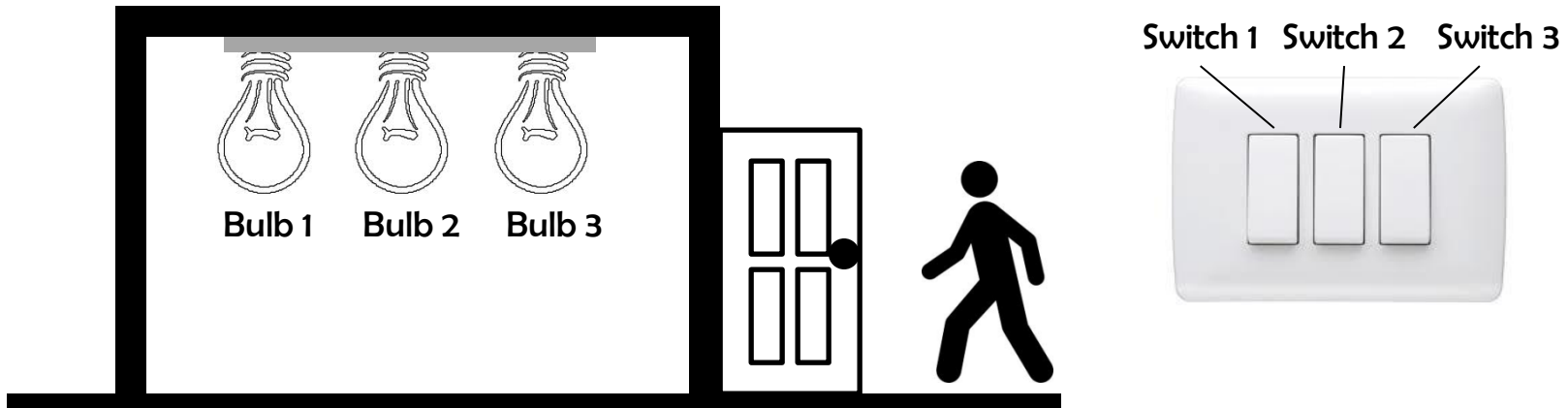

# Basic concepts of TRIZ

Before we get to the TRIZ tools, let's look at the 4 basic concepts of TRIZ



# What is systems approach?

A system

An organized, purposeful structure regarded as a 'whole' consisting of interrelated and interdependent elements (or components)

These elements (or components) continually influence one another (directly or indirectly) to maintain their activity and the existence of the system, in order to achieve the common purpose (or function) of the system

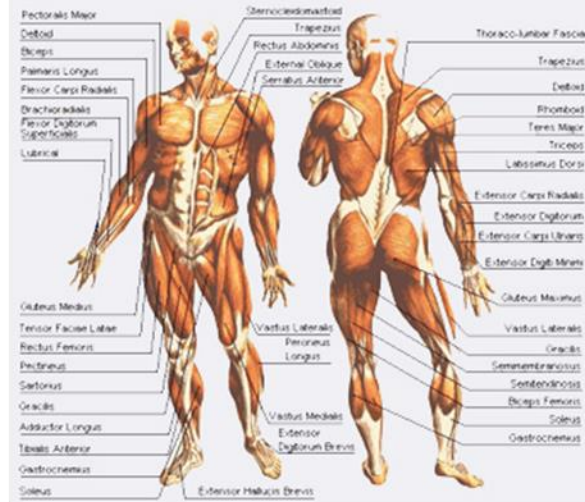

# What is contradiction?

**Contradiction is the opposition between two conflicting forces or ideas**

*Contra = opposing or opposite*

*Diction = point or speech*

*Contradiction = opposing point*

Living dead

New classic

Open secret

Solid water

Glass hammer

Invisible ink

Friendly fire

Serious joke

Deafening silence

Kalah menang

Hidup mati

Lawak gila



**TRIZ definition: The contradiction occurs when we are trying to improve one parameter of a technical system and then the same or other parameters of the technique are affected negatively.**



# Look for contradictions

- A key characteristic of an inventive problem
- Usual solution – trade-off or compromise
- Eliminating contradictions typically lead to invention

Speed ↑



**GOOD**

Gas Usage ↑



**BAD**

The car should travel faster (good),  
but consume more gas (bad)

Bandwidth ↑



**GOOD**

Power Usage ↑



**BAD**

The bandwidth for a communication  
system increases (good), but requires  
more power (bad)

**The inventor must find and remove contradictions**

# Types of contradictions

- Administrative contradiction is an explicit indication of one or more drawbacks that does not seem to be possible to avoid by known methods
  - We want to increase quality of production and decrease cost of raw materials
- Engineering contradiction is deterioration of one of the important features of the engineering system caused by improving of another one
  - The product gets stronger (good), but the weight increases (bad)
  - Service is customized to each customer (good), but the service delivery system gets complicated (bad)
- Physical contradiction is a couple of the opposite technical requirements to the physical state of an object
  - Coffee should be hot for enjoyable drinking, but cold to prevent burning the customer
  - Software should be complex (to have many features), but should be simple (to be easy to learn)



# What is ideality?



Plato (429-347 B.C.) – A Greek philosopher and great mathematician. Thought a lot about the natural world and how it works. He believed that everything had a sort of ideal form. He and his disciples advanced the understanding of infinity

- Each system evolves towards its ideal state
- The ideal state of the system is where it has all the benefits with none of the harm or none of the costs
- The system is better, faster, low cost, low error, low maintenance and so on (The ideal system consists of all positives and no negatives)
- The ideal system is a system that does not materially exist, while its functions are achieved (ideal system is no system)
- In the absolute sense Ideality is impossible to achieve, but in a relative sense ideality is achievable

# Evolve towards ideality

Let's take a look at the basic definition of value:

$$\text{value} = \frac{\text{functionality}}{\text{cost} + \text{harm}} = \frac{\sum F_{\text{useful}}}{\sum F_{\text{harmful}} + \sum F_{\text{cost}}}$$

If a system is to operate in an ideal stage, then the system must have at least 1 main useful function without any cost and harmfulness

$$\text{value} = \frac{1 \text{ useful function}}{0 \text{ cost} + 0 \text{ harm}} = \overset{\text{Infinity}}{\infty} = \text{ideality}$$

Final result: it has all the benefits and none of the costs and harmfulness

# Ways to make a system more ideal

- A** Increase the amount of functions of the system
- B** Transfer as many functions as possible to the working component which produces the system's final action
- C** Transfer some functions of the system to a supersystem or to the outside environment
- D** Utilize internal and external resources that already exist and are available



# What is resource?

- Every system has resources, some of which are fully used, some are partially used and some may not be used at all
- Resources are things (including waste), information, energy or properties of the materials that are already in or near the system
- Using resources, one can solve the problem and evolve towards the ideal state – the inventor has to evaluate what all resources are available in the system
- There may be resources in the system which are not yet identified - in many cases, identification of unidentified resources solve a problem very nicely
- Resource should be free or low cost and should be easily available

# Types of resources

## Substances

All substances in the system or in the external environment

## Energy

All kinds of energies and fields such as electrical, electromagnetic, thermal fields, etc in the system or in the external environment

## Time

All kinds of time before, during and after running of the system

## Functional

All possible functions of substance, fields, properties or object – can work as great resources

## Information

All kinds of data on parameters of substance, fields, change of properties or of object – typically used for measuring, detection and separation

## Combined

A combination of prime resources – a new resource could emerge through specific resource combination

# Looking for resources

What kind of resources are available in an electric wire?

Normally we will find the following resources:

- The wire itself
- Insulation around the wire
- The current in the wire
- Air around the wire
- ... and so on

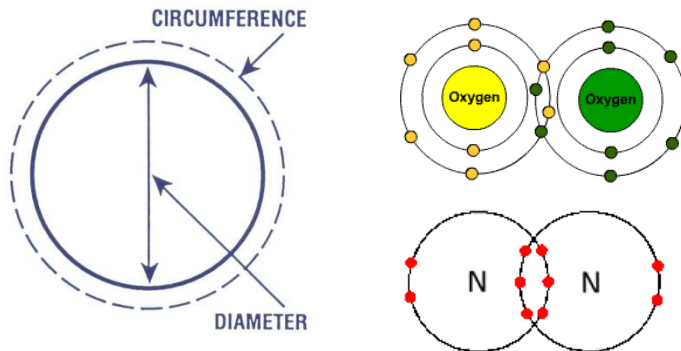
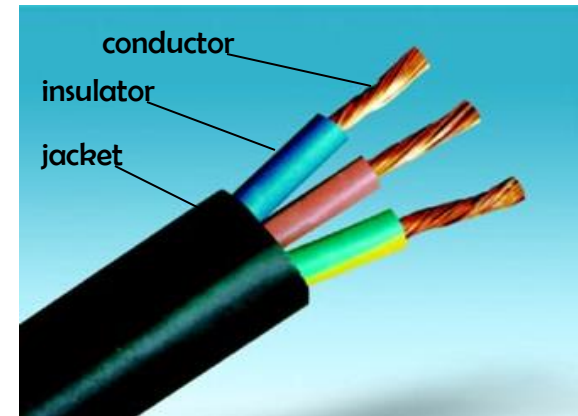

- In TRIZ, we include the geometrical aspects of the wire such as diameter, circumference, surface area, surface roughness, etc.
- The air as a resource is not just air, but the oxygen, nitrogen, carbon dioxide and other gases in the air

**How many more resources can you think of?**



# What is Structured Problem Solving?

## Step by Step Process



# Structured Problem Solving Process & TRIZ

## SPS



## TRIZ

- 
- TRIZ helps to define the real problem to be worked on vs. symptoms
  - Function Analysis of product or process
  - Ideality of Engineering Systems & focusing on Main Useful Function

- 
- Cause and Effect Chain helps to see other potential causes of problems
  - Scientific Effects database - better understanding of potential causes

- 
- Substance-Field Modeling, 76 Standard Inventive Solutions
  - 40 Inventive Principles – identify potential solutions
  - Predictions (Trends of Engineering System Evolution) – identifies evolutionary potential of interaction between components
  - ARIZ (Algorithm of Inventive Problem Solving)
- 

**TRIZ complements Structured Problem Solving**

**TRIZ is a “power” tool to add to an innovator’s toolbox**

# Engineering Contradiction & 39 System Parameters

## **MODULE 2**

# What is a Contradiction?

An improvement in one characteristic of a system results in the degradation of another characteristic

“As one characteristic gets better another characteristic gets worse”

- If I add heat, then productivity goes up, but it consumes more energy
- If I make the lift larger, then it is better to carry more loads, but it adds more weight
- If I increase the power of the car, then the speed will be improved, but the fuel consumption will go up

**Traditionally the problem is addressed by compromise, sacrifice or trade-off**

# What is an Engineering Contradiction?

- An Engineering Contradiction is a situation in which an attempt to improve one parameter of a system leads to the worsening (impairment) of another parameter
- It can be reflected in a positive and negative interaction between two or more components

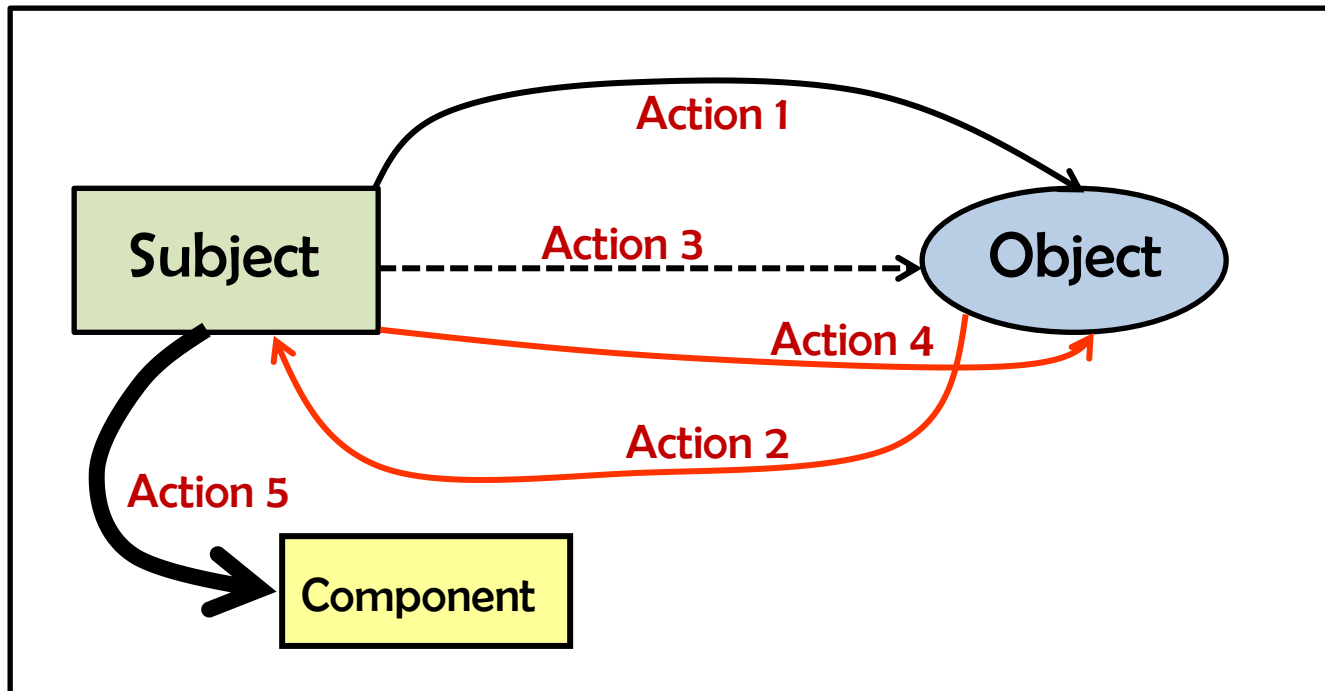

# Why are Contradictions important?

## System Evolution Paths

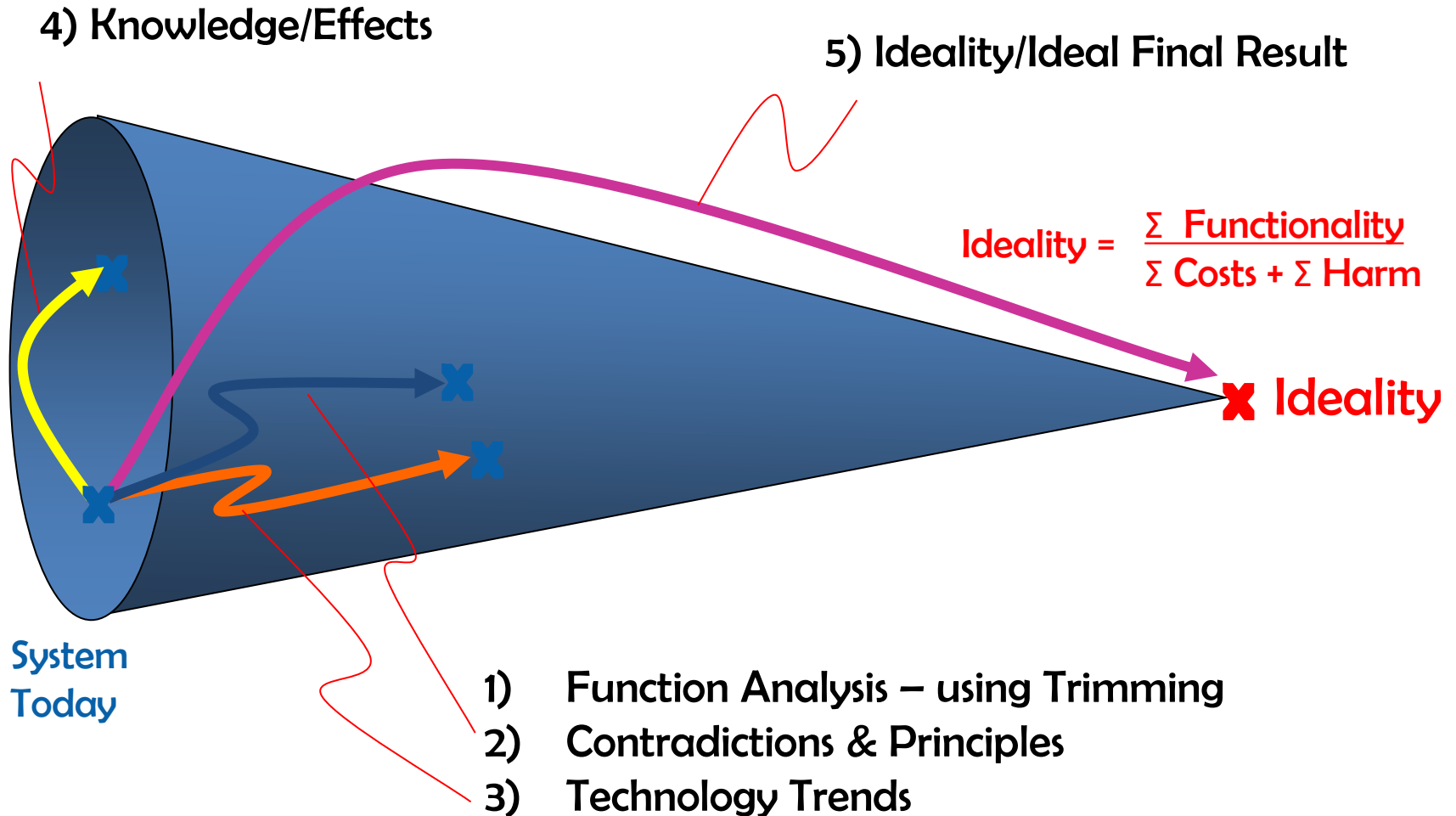

# Resolving Engineering Contradictions

- Identifying, understanding and resolving Engineering Contradictions within a system is a powerful way to improve the system
- It is possible to eliminate the Engineering Contradictions rather than looking for trade offs
- Use "If ... (manipulative variable changes) ... then ... (responding variable #1 improves) ..., but ... (responding variable #2 worsens) ..."

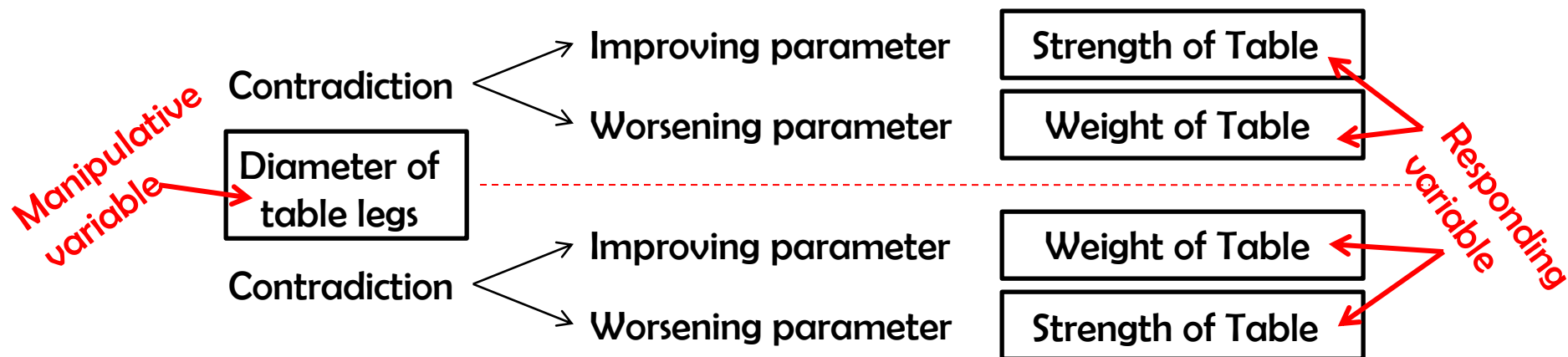

**If we increase the diameter of the table legs, then the table can carry a heavier load, but the table becomes heavier**

**If we increase the diameter of the table legs, then the strength of the table improves, but the weight of the table gets worse**

# What is parameter?

- Parameter is defined as any factor that defines a system and determines (or limits) its performance
- Parameter typically describes the characteristics of a system
- A parameter is a “property or attribute” given to describe a function of a system – it takes the point of view of the function rather than the components

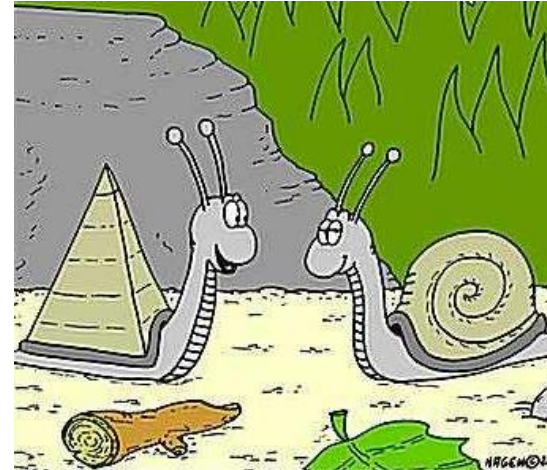



Yes, I'm from Egypt  
... how did you  
guess?





# 39 System Parameters

- 
1. Weight of Moving Object
  2. Weight of Stationary Object
  3. Length (or Angle) of Moving Object
  4. Length (or Angle) of Stationary Object
  5. Area of Moving Object
  6. Area of Stationary Object
  7. Volume of Moving Object
  8. Volume of Stationary Object
  9. Speed
  10. Force (a.k.a. Torque)
  11. Pressure or Stress
  12. Shape
  13. Stability of the Object's Composition
  14. Strength
  15. Duration of Action of Moving Object
  16. Duration of Action of Stationary Object
  17. Temperature
  18. Illumination Intensity
  19. Use of Energy by Moving Object
  20. Use of Energy by Stationary Object

- 
21. Power
  22. Loss of Energy
  23. Loss of Substance
  24. Loss of Information
  25. Loss of Time
  26. Quantity of Substance
  27. Reliability (Robustness)
  28. Measurement Accuracy
  29. Manufacturing Precision (Consistency)
  30. Object Affected Harmful Factors
  31. Object Generated Harmful Factors
  32. Ease of Manufacture (Manufacturability)
  33. Ease of Operation
  34. Ease of Repair (Repairability)
  35. Adaptability or Versatility
  36. Device Complexity
  37. Difficulty of Detecting and Measuring
  38. Extent of Automation
  39. Productivity

# Parameter #1: Weight of Moving Object

- The mass of or gravitational force exerted by a moving object
- Moving includes any situations where there is any degree of relative motion between two or more components related to the problem
- The movement may be linear or rotational from a few microns or a considerable distance



Equivalent meanings: burden, bulk, load, lightness

## Parameter #2: Weight of Stationary Object

- The mass of or gravitational force exerted by a stationary object
- Stationary includes any situations where there is no form of relative motion between two or more components related to the problem



Equivalent meanings: burden, bulk, load, lightness

## Parameter #3: Length (or Angle) of Moving Object

- Any linear or angular dimension relating to a moving object
- Moving includes any situations where there is any degree of relative motion between two or more components related to the problem
- The movement may be linear or rotational from a few microns or a considerable distance

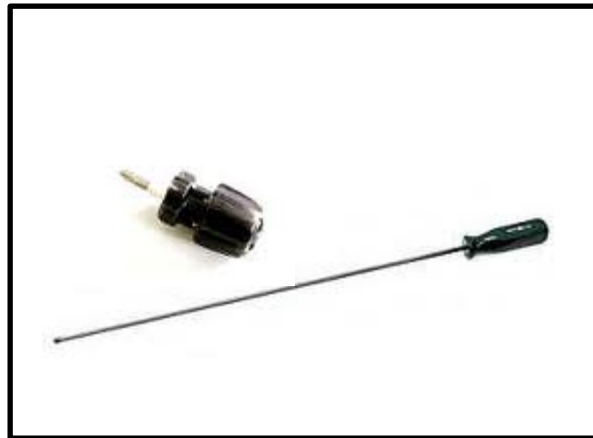

Equivalent meanings: width, height, depth, distance, range, span

# Parameter #4: Length (or Angle) of Stationary Object

- Any linear or angular dimension relating to a stationary object
- Stationary includes any situations where there is no form of relative motion between two or more components related to the problem

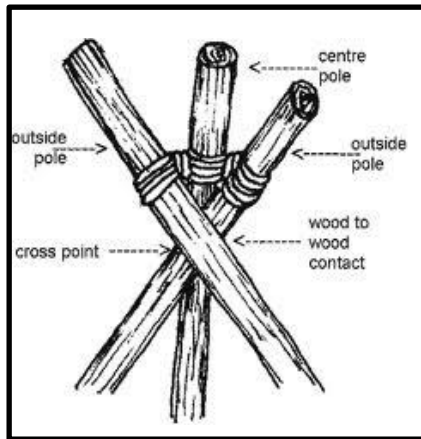

Equivalent meanings: width, height, depth, distance, range, span

## Parameter #5: Area of Moving Object

- Any dimension related to surface or surface area
- It may be internal or external surface area and may include contact area as well as actual surface area
- Moving includes any situations where there is any degree of relative motion between two or more components related to the problem
- The movement may be linear or rotational from a few microns or a considerable amounts



Equivalent meanings: region, space, zone, point of contact

## Parameter #6: Area of Stationary Object

- Any dimension related to surface or surface area
- It may be internal or external surface area and may include contact area as well as actual surface area
- Stationary includes any situations where there is no form of relative motion between two or more components related to the problem

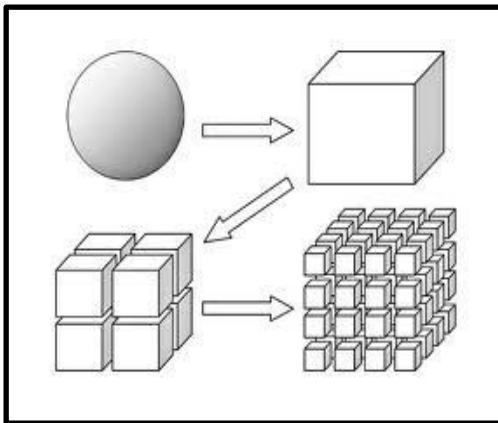

Equivalent meanings: region, space, zone, point of contact

## Parameter #7: Volume of Moving Object

- Any dimension related to the cubic measure of space occupied by an object or the space around it
- Moving includes any situations where there is any degree of relative motion between two or more components related to the problem
- The relative motion may be a few microns or a considerable distance



Waterfall



Oil spill

Equivalent meanings: capacity, space, room, size, bulk, compactness



# Parameter #8: Volume of Stationary Object

- Any dimension related to the cubic measure of space occupied by an object or the space around it
- Stationary includes any situations where there is no form of relative motion between two or more components related to the problem



Equivalent meanings: capacity, space, room, size, bulk, compactness

# Parameter #9: Speed

- The velocity of an object or the rate of any kind of process or action
- The speed may be relative or absolute
- It may be linear or rotational



Equivalent meanings: pace, haste, race, rush, rapidity, acceleration, slowness, tardiness

# Parameter #10: Force (a.k.a. Torque)

- Any interaction that is intended to change an object's condition
- It may be linear or rotational
- The term applies equally well to torque (a force that rotate an object about an axis)



Equivalent meanings: action, reaction, push, pull, twist, load, inertia, acceleration, momentum, change of momentum, intensity, lift, drag, thrust, moment, friction

# Parameter #11: Pressure/Stress

- Force exercised on a unit area
- Stress is the effect of forces on an object
- Stress can be tensile or compressive, static or dynamic
- Parameter also includes strain

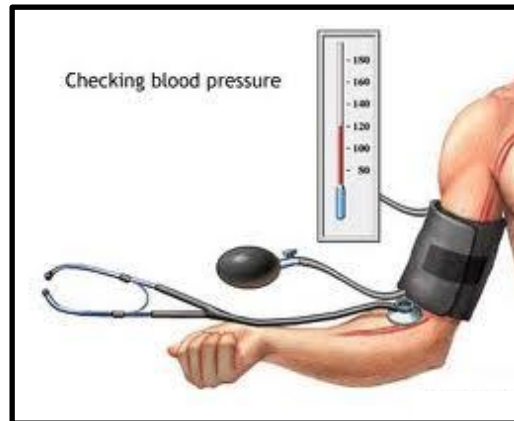
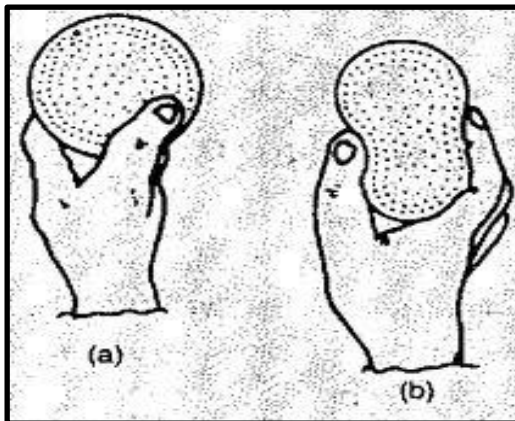

Equivalent meanings: compression, tension, creep, fatigue, elasticity, plasticity, stiffness, vacuum

## Parameter #12: Shape

- The internal and external contour of profile of a system or component as required for ergonomic and function



Equivalent meanings: pattern, profile, silhouette, form, outline, geometry, curvature, line

# Parameter #13: Stability of the Object's Composition

- The integrity of a system as referring to the relationship of a system's components
- It can be applied at system (component level) and subsystem level (atomic level)
- Decomposition, dissociation and increasing entropy should all be interpreted as issues concerning “stability”



Equivalent meanings: inertness, deformation, droop, tipping, distortion, oxidation, rusting, homogeneity, consistency, delamination

# Parameter #14: Strength

- The extent to which an object is able to resist changing in response to force
- Resistance in breaking – can be elastic limit, plastic limit, or the object's ultimate strength
- The parameter can be tensile or compressive, linear or rotational and includes toughness and hardness



Equivalent meanings: fatigue, creep, bond, join, muscle, droop, distortion, stillness, rigidity

# Parameter #15: Duration of Action of Moving Object

- The time taken by an object or system to perform an action
- The duration may take a few milliseconds or over several years
- This is different from reliability which is the duration to failure of a system
- This parameter is specific to only the duration of an action
- Moving includes any situations where there is any degree of relative motion between two or more components related to the problem
- The movement may be linear or rotational from a few microns or a considerable distance



Equivalent meanings: rate, period, frequency, mode, interval, phase, count, time span, delay



## Parameter #16: Duration of Action of Stationary Object

- The time taken by an object or system to perform an action
- The duration may take a few milliseconds or over several years
- This is different from reliability which is the duration to failure of a system
- This parameter is specific to only the duration of an action
- Stationary includes any situations where there is no form of relative motion between two or more components related to the problem



Equivalent meanings: rate, period, frequency, mode, interval, phase, count, time span, delay

# Parameter #17: Temperature

- This parameter is the measured thermal condition of an object or system
- It includes parameter such as heat capacity, conductivity, radiation and convection



Equivalent meanings: conduction, convection, radiation, insulation, freezing, melting point, boiling point, heating, warmth, cooling, overheating

# Parameter #18: Illumination Intensity

- This parameter is the measure of light flux per unit area
- It is related to characteristics of a system such as color, brightness, light quality, etc
- The parameter applies to both the brightness of a light source and illumination of an object



Equivalent meanings: color, visibility, emissivity, camouflage, transmission, absorption, reflection, reflectivity, frequency, shade, tone, luster, matt, shiny, surface finish

# Parameter #19: Use of Energy by Moving Object

- This parameter is the measure of an object's capacity for doing work
- It focuses on the actual amount of energy
- Moving includes any situations where there is any degree of relative motion between two or more components related to the problem
- The movement may be linear or rotational from a few microns or a considerable amount

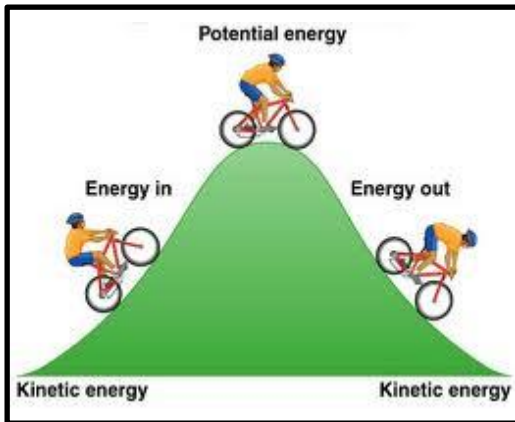

Kinetic & potential energy

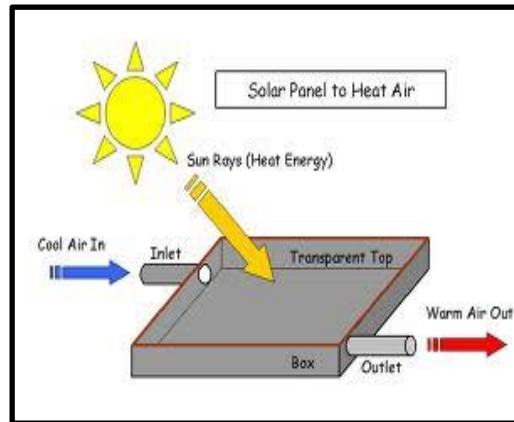

Solar & heat energy



Making fire

Equivalent meanings: fuel burn, consumption, heat-input, heating, cooling, calories, current

# Parameter #20: Use of Energy by Stationary Object

- This parameter is the measure of an object's capacity for doing work
- It focuses on the actual amount of energy
- Stationary includes any situations where there is no form of relative motion between two or more components related to the problem



Energy used while sleeping

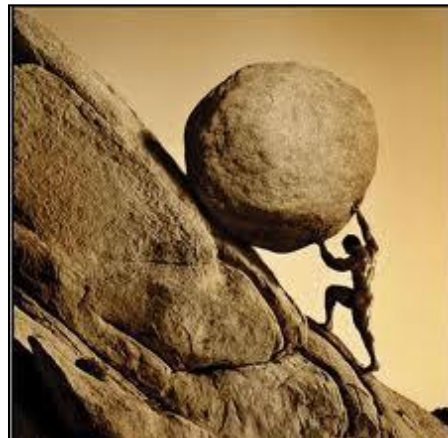

Potential Energy



High calorie-energy food

Equivalent meanings: fuel burn, consumption, heat-input, heating, cooling, calories, current

## Parameter #21: Power

- This parameter is the measure of rate of which work is performed.
- It is the rate of use of energy or the rate of energy output



Equivalent meanings: wattage, current, impulse, peak, steady, horsepower, action intensify

## Parameter #22: Loss of Energy

- This parameter is the measure of loss or wastage of energy that does not contribute to any of the useful information being performed
- Inefficiency that can be partial or complete, or permanent or temporary



Energy loss in the home



Electric energy loss



Pendulum slows down

**Equivalent meanings: Friction, stiction, dissipation, turbulence, wake, interference, damping**

## Parameter #23: Loss of Substance

- This parameter is the measure of loss or wastage of a system or its surroundings such as substances, materials, subsystems, products, fields, etc.
- It can be partial or complete, or permanent or temporary



Water leakage



Shoes wear and tear



Worn out tire

**Equivalent meanings: leak, wear, waste, abrasion, seal, absorption, desorption, deposition**



## Parameter #24: Loss of Information

- This parameter is the measure of loss or waste of data associated with any of the 5 senses – sight/visual, hearing/auditory, touch/kinesthetic, smell/olfactory or taste/gustofactory
- It can be partial or complete, or permanent or temporary
- It can also mean the amount of quantity or number of a system's resources



Hard disk crash



Television interruption



Phone network failure

**Equivalent meanings: misunderstanding, interference, distortion, filter, corruption, knowledge, data, memory, properties, message, capacity**

## Parameter #25: Loss of Time

- This parameter is the measure of time inefficiencies for example waiting periods, slack time, etc
- It can be partial or complete, or permanent or temporary



Tortoise and Hare race



Being unproductive



Footballer delaying time

**Equivalent meanings: delay, duplication of effort, time lost on redundant, unnecessary activities**

## Parameter #26: Quantity of Substance

- This parameter is the measure of amount, quantity or number of a system's materials, substances, parts, fields or subsystems
- Substance is used in its most generic form in the TRIZ context to include any physical or temporal thing



Quality of Gold



Clean and dirty water

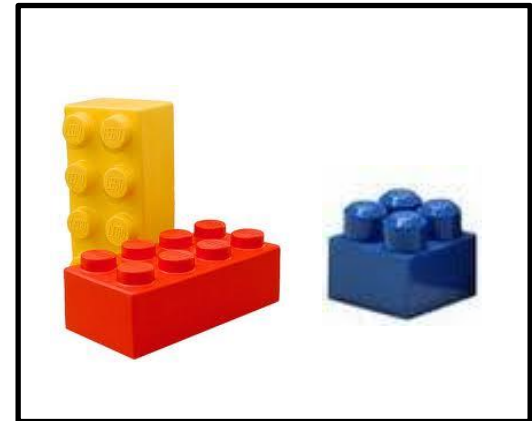

Real vs imitation quality

Equivalent meanings: body, matter, stuff, density, particle count, flesh

# Parameter #27: Reliability

- This parameter is the measure of a system's ability to perform its intended functions in predictable ways and conditions
- It also includes durability and issues related to the performance and degradation in performance of an object or system over prolonged periods



Life Jacket



Parachute



Fire extinguisher

Equivalent meanings: life-cycle, life, in-service, mean-time-between-failures, mean-time between overhaul, integrity, maintenance, failure rate, durability

## Parameter #28: Measurement accuracy

- This parameter is the degree of precision or accuracy.
- The closeness of a measured value to an actual value of a property of a system
- It can also be measurement error



High precision injection –  
petrol direct injection system



Precision tweeter



Using digital microscopy for  
accurate measurement

**Equivalent meanings: tolerance, error, repeatability, consistency,  
standard deviation**

# Parameter #29: Manufacturing precision (consistency)

- This parameter is the degree to which the actual characteristics of a system or object match in specified or required characteristics
- It is the accuracy of the system



Car production



Bottle Filling

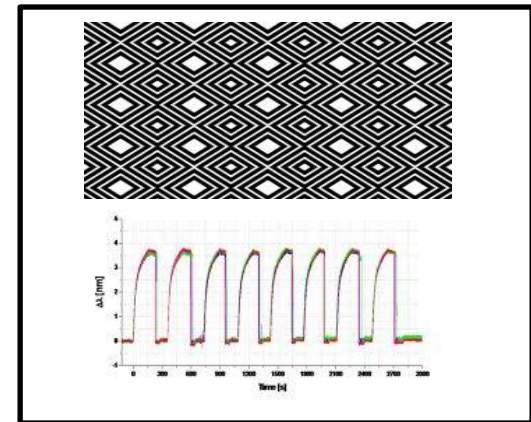

Pattern - repeatability  
Consistent Delivery, High Reproducibility

Equivalent meanings: tolerance, repeatability, standard deviation, sigma level, quality assurance, accuracy

## Parameter #30: Object affected harmful factor

- This parameter is designed as a catch-all for any form of action or phenomenon in or around a system that manifests itself as a harmful effect on something in the system



Equivalent meanings: undesired effect, contamination, adhesion, sticking, weather damage, sun damage, UV damage, warpage, dust ingestion, mold impact

# Parameter #31: Object generated harmful factor

- This parameter is designed as a catch-all for any form of inefficiency internal to or around a system that manifests itself as a harmful effect on something in the system
- It can also mean any form of pollutant or environmental emission generated by a system or object
- This is a derivative of the “loss of substance” (principle #23) definition but the focus in this principle is on “harmful emissions”
- This aspect is on the production of chemicals that were not one of the original substances contained within the system



Equivalent meanings: contamination, infection, abrasion, taste, mouth-feel, hand-feel, EMI, RFI, side-effect – CO<sub>2</sub>, NO<sub>2</sub>, NO, SO<sub>2</sub>, O<sub>3</sub>, CFC, odor)



## Parameter #32: Ease of manufacturability

- This parameter is related to manufacturing, fabrication, assembly issues associated with an object or system
- It can be a measure of ease of manufacturability



**Equivalent meanings: design for manufacturability, design for assembly, tool change, convenience of manufacture, machine-setting time, tool-change**

## Parameter #33: Ease of operation

- This parameter is the extent to which a user is able to learn how to operate or control a system or object
- It can relate to the convenience of use



Equivalent meanings: training, education, usability, learning-curve, familiarization-time, ease of use, ease of transport, movability

## Parameter #34: Ease of repair

- This parameter is the quality characteristics such as convenience, comfort, simplicity and time to repair faults, failures or defects of a system
- It includes issues associated with need for special tooling or equipment required to achieve repair



Equivalent meanings: maintenance, accessibility, recoverability, removability, cleanability, replaceability., modularity, interchangeability, convenience of repair

## Parameter #35: Adaptability/Versatility

- This parameter is the extent to which a system or object is able to respond to external changes.
- It relates to a system capable of being used in multiple ways or under a variety of circumstances
- It can be flexibility of operation, or customizability



Equivalent meanings: switching, modulation, variation, compliance, rigidity, tolerance, universality, trainability

# Parameter #36: Device Complexity

- This parameter is the number and diversity of elements and element inter-relationships within and across the boundaries of a system
- The user of the system may be considered an element if the system increase the complexity
- It can be number of functions, number of interfaces, or number of connections, or excessive number of components
- The complexity of the control element of a system whether it is physical components or algorithms that the system contains

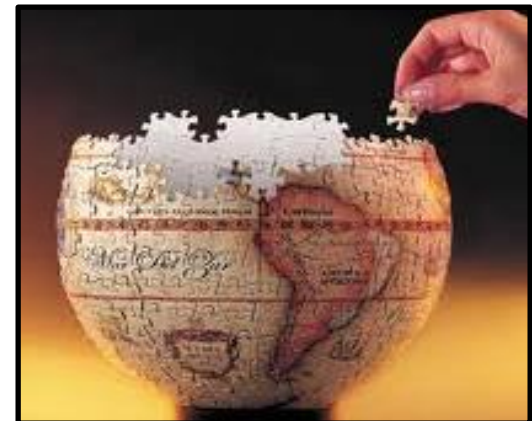
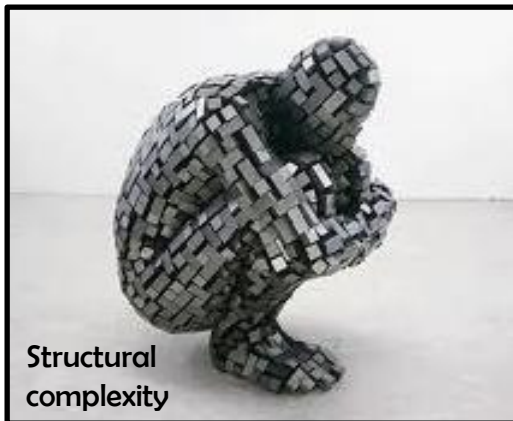

Equivalent meanings: part count, interfaces, device complexity, object complexity, proportion, differential,

# Parameter #37: Difficulty of Detecting and Measuring

- This parameter is the difficulty to make measurements on an object or system
- It can be complex, time consuming and labor consuming inspection or analysis operations
- It increases the cost of measuring to a satisfactory quality level
- It includes ease of inspection



**Equivalent meanings: Accessibility, visibility, location, integrity, ability to find right parameter to measure**

## Parameter #38: Extend of Automation

- This parameter is the ability of a system or object to perform its functions without human interface or intervention
- It can be level or extent of automation



Equivalent meanings: robot, man out of the loop, deskilling, repeatability

## Parameter #39: Productivity

- This parameter is the number of useful (value-adding) functions or operations performed by a system per unit time.
- It can be the time per unit function or operation, useful output per unit of time, cost per unit output, or amount of useful output

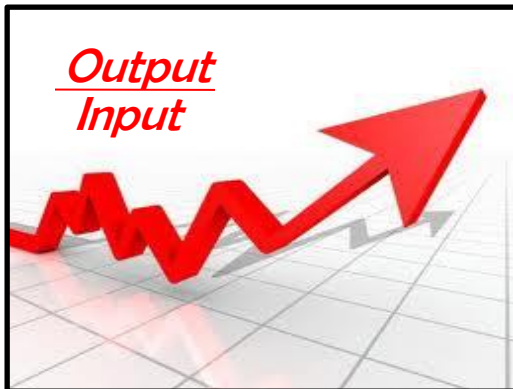

Equivalent meanings: output, value, throughput, bottlenecks



40 Inventive Principles

**MODULE 3**

# What is an inventive principle?

- Is a basic generalized rule that is accepted as facts, works in exactly the same way consistently and usually followed as a basis of reasoning or explanation of the invention



Telephone

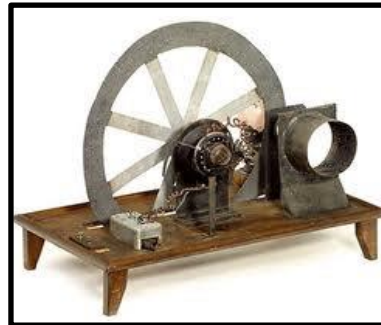

Television



Car

Altshuller screened 200,000 patents in order to find out what kind of contradictions were resolved by each invention and the way it was achieved. He synthesized down to 40,000 innovative patents (i.e. patents which had contradictions) and from this, he developed a set of 40 Inventive Principles. Let's review the 40 Inventive Principles ...

# 40 Inventive Principles

- 
1. Segmentation
  2. Taking Out or Extraction
  3. Local Quality
  4. Asymmetry
  5. Merging or Combination
  6. Universality
  7. Nested Doll
  8. Anti-weight or Counter weight
  9. Preliminary anti action/Prior counter action
  10. Preliminary action/Prior action
  11. Beforehand cushioning/Prior Cushioning
  12. Equipotentiality/Remove tension
  13. The other way around
  14. Spheroidality-Curvature
  15. Dynamics
  16. Partial or excessive actions
  17. Another dimension
  18. Mechanical vibration
  19. Periodic action
  20. Continuity of useful action

- 
21. Skipping/Hurrying
  22. Blessing in Disguise
  23. Feedback
  24. Intermediary
  25. Self-service
  26. Copying
  27. Cheap/Short Living
  28. Mechanics substitution/Another sense
  29. Pneumatics and hydraulics/Fluidity
  30. Flexible shells and thin films/Thin & flexible
  31. Porous Materials/Holes
  32. Color changes
  33. Homogeneity
  34. Discarding and recovering
  35. Parameter changes
  36. Phase transitions
  37. Thermal expansion/Relative change
  38. Strong oxidants/Enriched Atmosphere
  39. Inert Atmosphere/Calmed Atmosphere
  40. Composite materials/Composite structure

# Principle #1: Segmentation

- a. Divide an object into independent parts
- b. Make an object sectional – for easy assembly and disassembly
- c. Increase the degree of an object's segmentation or fragmentation
- d. Transition to micro-level



Furniture



Camping Tent



Many roller conveyor system

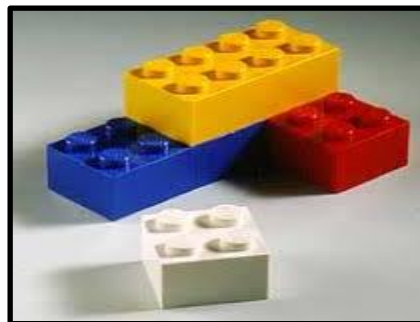

Lego blocks



3D Puzzle

## Principle #2: Taking Out

- a. Separate an interfering part or property from an object
- b. Extract the only necessary part or property of an object

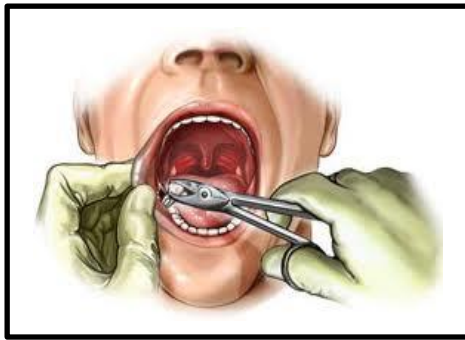

Tooth Extraction



Aircon compressor unit



Medical ampoules



Deep sea diving with oxygen supply via pressure oxygen tube

## Principle #3: Local quality

- a. Change an object's structure from uniform to non-uniform
- b. Change an external environment or external influence from uniform to non-uniform
- c. Make each part of an object function in conditions most suitable for the operation
- d. Make each part of an object fulfill a different and useful function

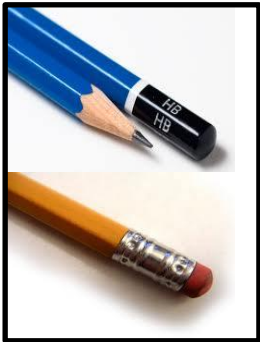

Pencil with eraser



Hammer with claw



Thumb Drive with MP3 player



USB/MP3/Watch

# Principle #4: Asymmetry

- a. Change the shape of an object from symmetrical to asymmetrical
- b. If an object is already asymmetrical, increase its degree of asymmetrical



Chair Design



Hair Style



Fashion



Face

# Principle #5: Merging

- a. Bringing closer together identical or similar objects
- b. Assemble identical or similar objects to perform parallel operations
- c. Make operations contiguous or parallel – bring them together in time



Combined toilet



Remove partitions and combined to make a larger room



Many rowers in a boat working together to move the boat faster



A triple hull ship reduce the interference of waves between hulls reduce rocking

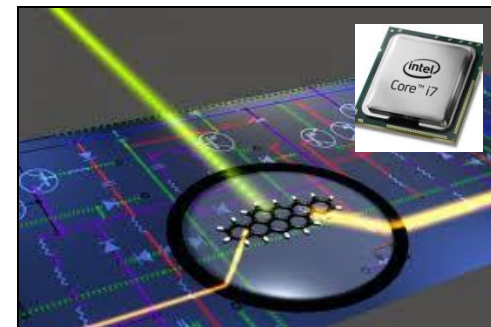

Millions of transistors fabricated together to form a microprocessor



# Principle #6: Universality

- a. Make a part or an object perform multiple functions – eliminate the need for other parts
- b. Use standardized features



Child car safety seat converts into a stroller or carry-on basket



Camper van with beds, kitchen, sofa



Smart phones with PDA, GPS, camera, Wi-Fi



Toilet with a heated seat, auto water jet



Photocopier with printer, scanner and fax

# Principle #7: Nested doll

- a. Place one object inside another, place each object, in turn, inside the other
- b. Make one part pass through a cavity in the other



Matrioshka Dolls



Stacking cups



Tripod stand



Luggage bags



Antenna of a car which can be retracted or extended

# Principle #8: Anti-weight

- a. To compensate for the weight of an object, combine it with another object that provides a lifting force
- b. To compensate for the weight of an object, make it interact with the environment



Helium balloon for advertising



Helium balloons helps to temporarily suspend a cable over the river

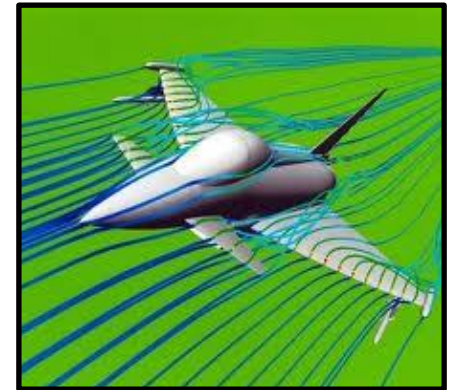

Plane wings – aerodynamic

## Principle #9: Prior counter-action

- a. If it will be necessary to do an action with both harmful and useful effects, this action should be replaced with anti-actions to control the harmful effects
- b. Create beforehand stresses in an object that will oppose known undesirable working stresses later on



Sleeping pills can pose a risk of overdose. Introduce a vomit inducing ingredient into the sleeping pills. If the vomit inducing ingredient exceed a certain threshold, it trigger the body to react by vomiting. This is to prevent overdose.

## Principle #10: Prior action

- a. Perform the required change to an object before it is needed
- b. Pre-arrange objects such that they can come into action from the most convenient place and without losing time for their delivery



Volleyball spikers indicate next attack plan by using hand signals to communicate ahead with setter



Meat prepared and marinated before it is barbequed or cooked



Pre-packed food

# Inventive Principles – Exercise #1

Instructions:

Draw a line to match the pictures and the principles adopted



Segmentation

Taking out

Local quality

Asymmetry

Merging

Universality

Nested doll

Anti weight

Preliminary anti-action

Preliminary action



# Inventive Principles – Exercise #1

Instructions:

Draw a line to match the pictures and the principles adopted



Segmentation

Taking out

Local quality

Asymmetry

Merging

Universality

Nested doll

Anti weight

Preliminary anti-action

Preliminary action



# Principle #11: Beforehand cushioning

- a. Prepare emergency means beforehand to compensate for the relatively low reliability of an object



Back-up parachute



Airbags in car



F1 car race use old tires to prevent accidents



Running shoes



A magnetic plate is inserted into products to prevent shoplifting





# Principle #12: Equipotentiality

- a. In a potential field, limit position changes – change operating conditions to eliminate the need to raise or lower objects in a gravity field

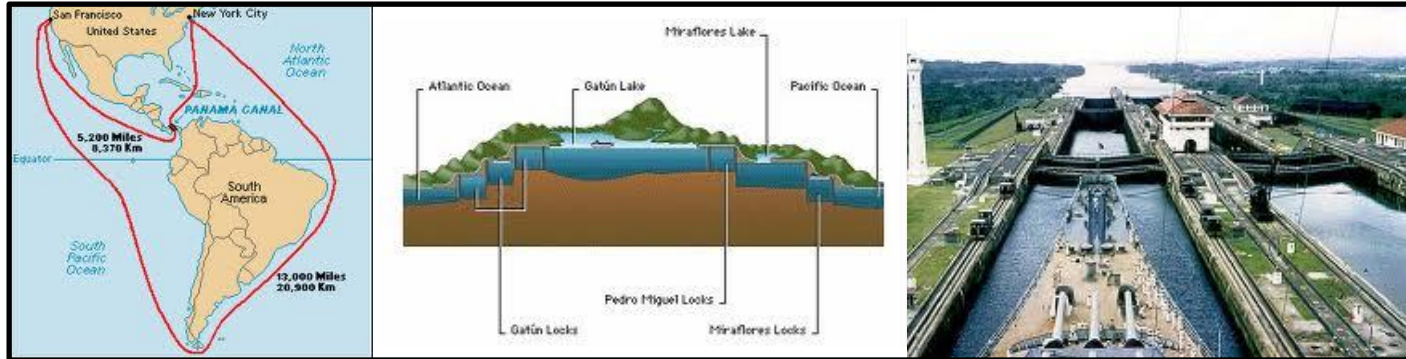

Panama Canal is a major shipping canal which connects the Atlantic and Pacific Oceans. Since the water levels of the ocean and lake are different, water elevators are used to raise and lower ships from ocean to lake and vice versa to achieve equipotentiality, as they cross the Panama Canal



Hydraulic Stylist Chair that can be raise or lower with tap of foot



Massage chair that can be changed by electronic control



Garbage truck does not need to lift the load, it is lifted by a hydraulic cylinder then slid inside the truck

## Principle #13: The other way around

- a. Invert the action used to solve the problem
- b. Make moveable parts fixed and fixed parts moveable
- c. Turn the object or process upside down



Change the magnetic crane for moving cars in a scrap yard from electromagnet to permanent magnet. Use electric power only when releasing the car by activating a counter electromagnet. Cars are supported even during sudden power outage



A swimming training pool with pump installed to move the water instead of the swimmer



Lace a snow boot from the back instead of the front

# Principle #14: Curvature

- a. Instead of using linear parts, surfaces or forms, adopt a curve ones
- b. Move from flat surfaces to spherical ones
- c. Change from parts shaped as cube (parallelepiped) to ball shaped structures
- d. Use rollers, balls, spirals or domes
- e. Go from linear to rotary motion – use centrifugal forces



Tiny metal ball rotates at the end of the pen tip – act as cap, enable control flow of ink and avoid clogging



Deodorant dispenser

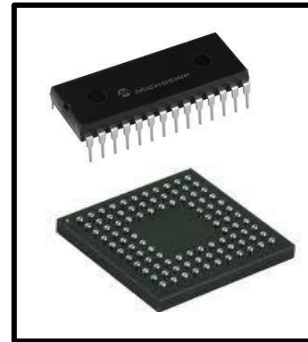

Change semiconductor packaging technology from rectilinear leads and pins to spherical balls



Increase the curvature of sunglasses to improve the protection

# Principle #15: Dynamization

- a. Allow for the characteristics of an object, external environment, or process to change to be optimal or to find an optimal operating condition
- b. If an object is rigid or inflexible, make it movable or adaptive
- c. Divide an object into parts capable of movement relative to each other



Expandable Table



Bicycle Chain



Flexible vehicle for rough terrain

# Principle #16: Partial or excessive action

- a. If 100% of an object is hard to achieve using a given solution method then, by using “slightly less” or “slightly more” of the same method – the problem may be considerably easier to solve



Using large concrete hammer to break floor



Big wheel truck for better control, better ride and better protection of driver



In screen printing, excessive ink is applied on stencil and a squeegee is used to wipe off the excess ink

# Principle #17: Another dimension

- Move an object in two or three dimensional space
- Use a multi-storey arrangement of objects instead of a single storey arrangement
- Tilt or re-orient the object, lay it on its side
- Use “another side” or opposite side of a given area



Multi parking system leveraging height dimension to increase capacity



Compact Disc changer with many stacked CD's

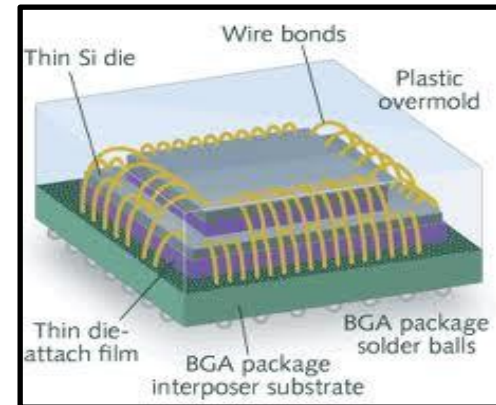

Multi layer stacked die or stacked package in semiconductor packaging

# Principle #18: Mechanical vibration

- Cause an object to vibrate or oscillate
- Increase its frequency even up to the ultrasonic
- Use an object's resonant frequency
- Use piezoelectric vibrators instead of mechanical ones
- Use combined ultrasonic and electromagnetic field oscillation

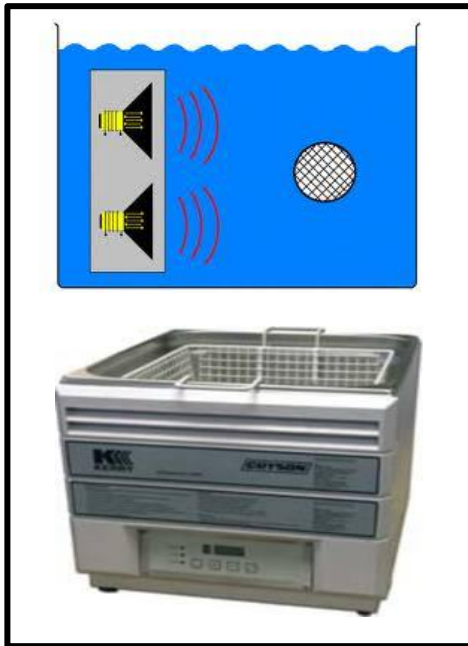

Ultrasonic cleaning

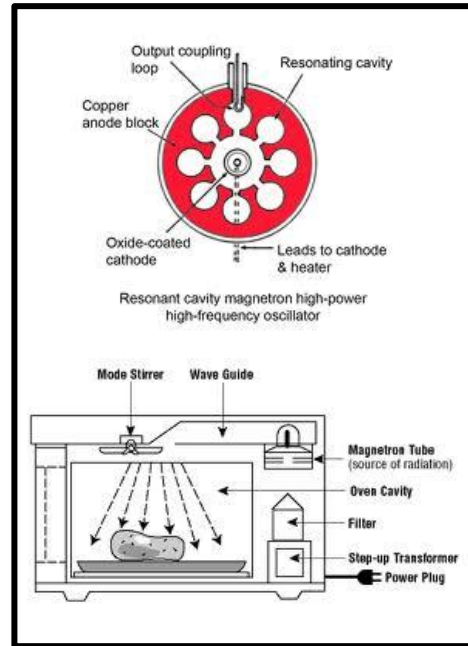

Microwave oven



Ultrasonic resonance

# Principle #19: Periodic Action

- Instead of continuous action, use periodic or pulsating actions
- If an action is already periodic, change the periodic magnitude or frequency
- Use pauses between impulses to perform a different or additional action



Pulsating water jet is used to break concrete



Pulsed sprinkler system – reduce damage to crops



Smoke signal – ring of smoke is clearer and travel higher



# Principle #20: Continuity of useful action

- Carry on work continuously - make all parts of an object work at full load, all the time
- Eliminate all idle or intermittent actions or work
- Replace “back and forth” motion with a rotating movement



An instrument that consistently measure intervals of time



Operate shop or manufacturing facility at 24 hours a day, 7 days a week to maximize tool usage



Print during the return of a printer carriage in dot matrix and inkjet printers

# Inventive Principles – Exercise #2

Instructions:

Draw a line to match the pictures and the principles adopted

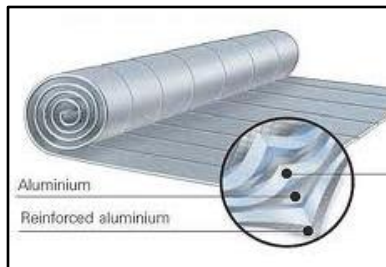

- Beforehand cushioning
- Equipotentiality
- The other way around
- Curvature
- Dynamization
- Partial/excessive action
- Another dimension
- Mechanical vibration
- Periodic action
- Continuity of useful action



# Inventive Principles – Exercise #2

Instructions:

Draw a line to match the pictures and the principles adopted

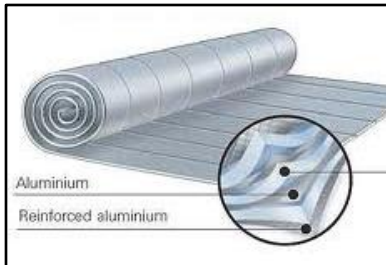

- Beforehand cushioning
- Equipotentiality
- The other way around
- Curvature
- Dynamization
- Partial/excessive action
- Another dimension
- Mechanical vibration
- Periodic action
- Continuity of useful action



# Principle #21: Rushing through/Skipping

- a. Perform harmful and hazardous operations at a very high speed



To avoid heating the gum tissues, use a high speed dentist's drill

## Principle #22: Blessing in disguise

- Utilize harmful factors – especially environmental to obtain a positive effect
- Remove one harmful factor by combining it with another harmful factor
- Increase the degree of harmful action to such an extent that it ceases to be harmful

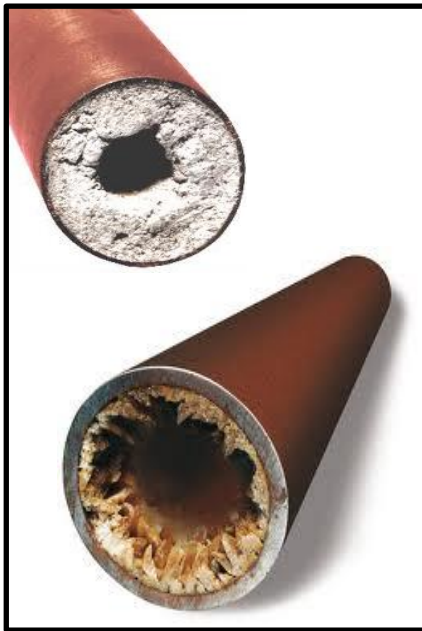

When the base liquid is pumped through a pipe, it will deposit sediment on the inside surface of the pipe. When acid is pumped through the pipe, it corrodes the inner surface of the pipe. Pump acid and base liquid alternatively through the same pipe



Before demolishing an old building, dig a trench around it. During the demolish/blasting, the shock wave reaches the trench, reflects back and neutralizes the main shock wave

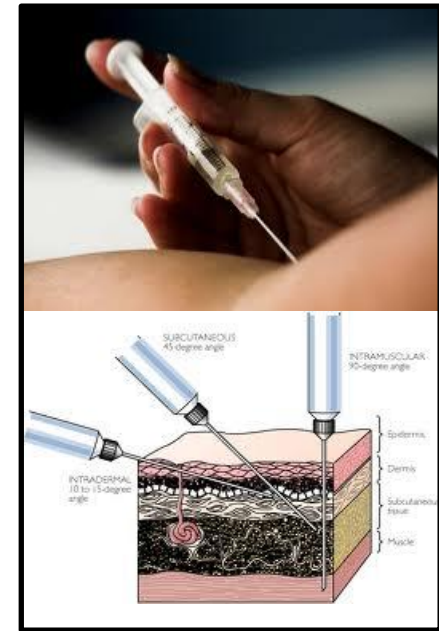

Removal of red birth marks is accomplished by injecting a compensating green pigment under the skin

# Principle #23: Feedback

- a. Introduce feedback
- b. If feedback already exists, change it



Fuel Gauge



Feedback Form

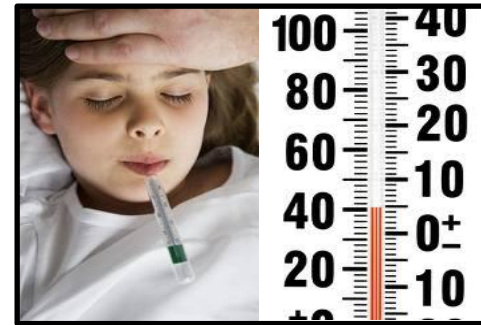

Thermometer



Speedometer

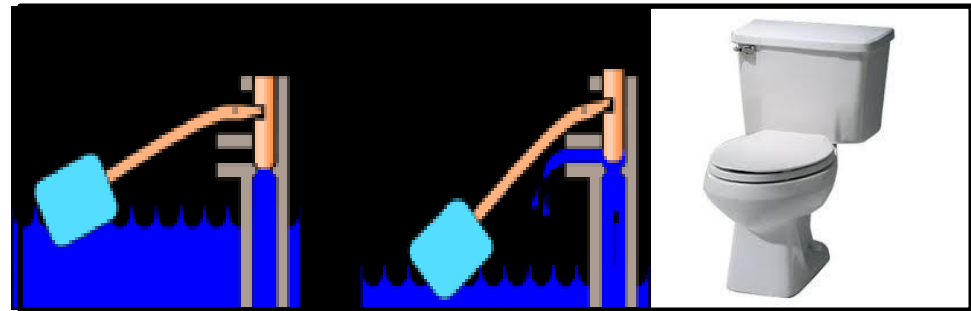

The Float Valve used to regulate the filling of a toilet tank or cistern.

# Principle #24: Mediator

- a. Use an intermediary object to transfer or carry-out an action
- b. Temporarily connect the original object to one that is easily removed



Correction paper in  
solution or tape form

# Principle #25: Self service

- a. An object must service itself and carry out supplementary and repair operations
- b. Make use of waste material and energy



Air pressure in the tanks of an aqualung is 200 psi. Before the air reaches the lungs of the diver, the pressure must be reduced to 3-4 psi. This can be accomplished by passing the compressed air through a device that drives a flexible propulsion fin on the back of the diver. Travel distance underwater was increased by 7 times



# Principle #26: Copying

- a. A simplified and inexpensive copy should be used in place of a fragile original or an object that is inconvenient to operate
- b. If a visible optical copy is used, replace it with an infrared or ultraviolet copy
- c. Replace an object (or system of objects) with their optical image. The image can be reduced or enlarged



Flight simulation



Animated backdrop



The doctor can see a patient as a 3D image by using a stereoscope

# Principle #27: Cheap short living objects

- a. Replace an expensive object with a cheap one, compromising other properties (ie. Longevity)



Disposable cup



Disposable shaver



Disposable diaper

# Principle #28: Mechanical Substitution

- a. Replace a mechanical system with an optical, acoustical, thermal or olfactory system
- b. Use an electric, magnetic or electromagnetic field to interact with an object
- c. Replace fields that are stationary with mobile, fixed with changing in time and random with structured
- d. Use fields in conjunction with ferromagnetic particles



Olfactory (sense of smell) method to determine when a tooth of a boring tool is broken – odorous substance



Control of polishing process is done through a speaker. A different sound from the speaker indicates the end of the process



Micro-movement of an object under a microscope is done with a metal rod and an electric heating element

# Principle #29: Pneumatic & Hydraulic

- a. Replace a solid parts of an object with a gas or a liquid. These parts can now use air or water for inflation, or use pneumatic or hydrostatic cushions



Pipe Organ



Car brake

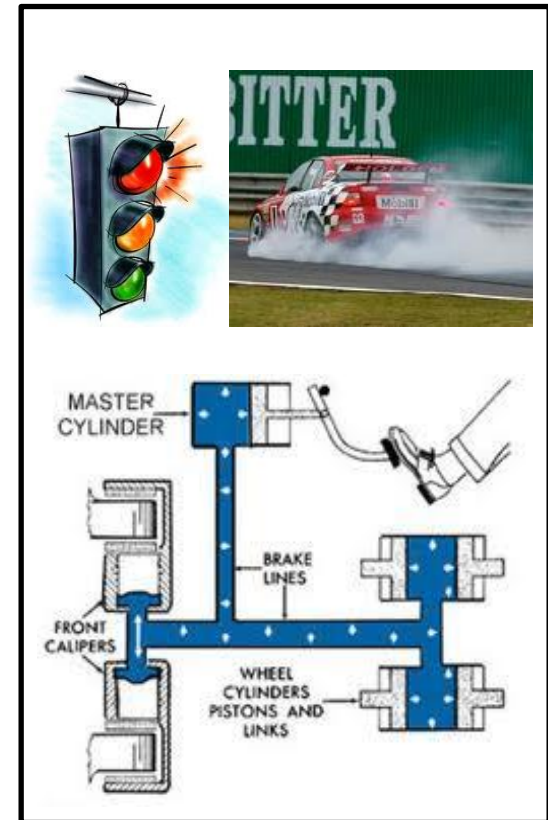

Air brake

# Principle #30: Flexible shells and thin films

- a. Replace customary constructions with flexible membranes or thin film
- b. Isolate an object from its outside environment with flexible membranes or thin films



A mirror with adjustable focus is made out of thin, flexible film. When air is pumped inside of the enclosure, it changes the curvature of the mirror



Plastic food wrapper



A light bulb covered with a thin rubber film can withstand high impact – shatter proof

# Inventive Principles – Exercise #3

Instructions:

Draw a line to match the pictures and the principles adopted

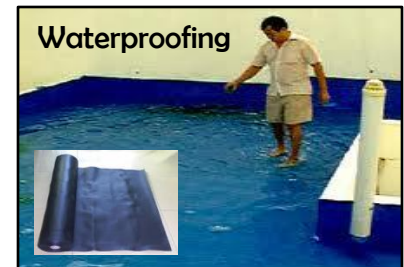
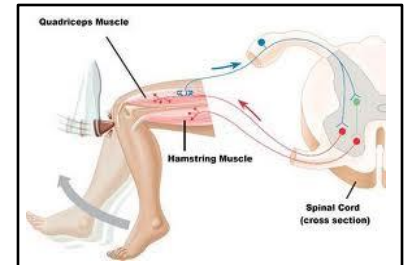
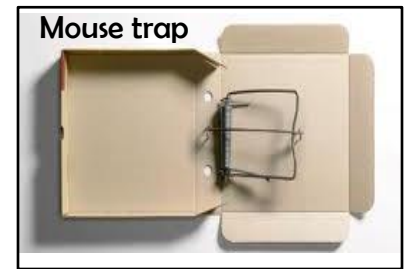

- Rushing through/Skipping
- Blessing in disguise
- Feedback
- Intermediary
- Self service
- Copying
- Cheap short-living objects
- Mechanics substitution
- Pneumatics/Hydraulics
- Flexible shells & thin films

# Inventive Principles – Exercise #3

Instructions:

Draw a line to match the pictures and the principles adopted

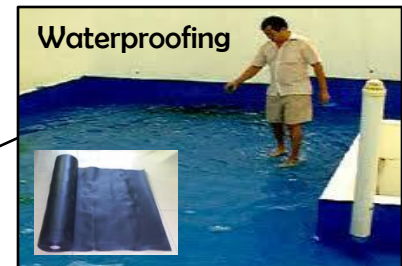
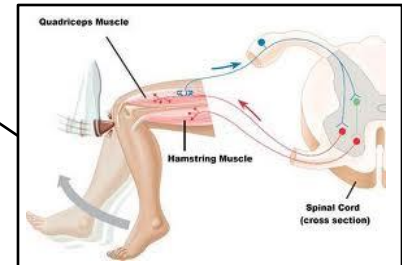
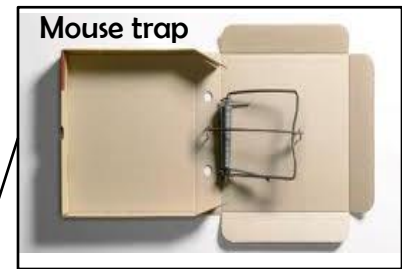

- Rushing through/Skipping
- Blessing in disguise
- Feedback
- Intermediary
- Self service
- Copying
- Cheap short-living objects
- Mechanics substitution
- Pneumatics/Hydraulics
- Flexible shells & thin films

# Principle #31: Porous Material

- a. Make an object porous, or use supplementary porous element (inserts, covers, etc)
- b. If an object is already porous, fill pores in advance with some substance



Since a solid brick is heavy, introduce holes in the brick to reduce weight while still maintaining its strength

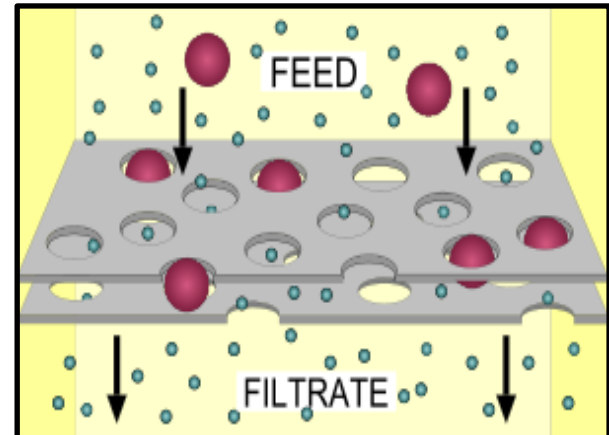

In a hydraulic system, oil is pumped through a porous plate that works as a control valve



# Principle #32: Color change

- a. Change the color of an object or its environment
- b. Change the degree of translucency of an object or its environment
- c. Use color additives to observe an object, or process, which is difficult to see
- d. If such additives are already used, employ luminescent traces or trace atoms



Baby feeding spoon –  
change color depending  
on temperature



Ziplock bag – tight seal



A bandage is made out of  
transparent material for better  
observation of the wound

# Principle #33: Homogeneity

- a. Objects interacting with the main object should be made out of the same material (or material with similar properties) as the main object



Make a diamond cutting tool out of diamond



Use sand blasting to create an imprint on glass since both materials are made of silicon



Glass cutter made out of diamond

# Principle #34: Discarding and recovering

- a. After completing its function, or becoming useless, an element of an object is rejected (discarded, dissolved, evaporated, etc.) or modified during its work process
- b. Used up parts of an object should be restored during its work



Environmentally safe, biodegradable bottles



Biodegradable plastic bags



Dissolving capsules for medicine

# Principle #35: Parameter changes

- a. Change an object's physical state (e.g. to a gas, liquid or solid)
- b. Change the concentration or consistency
- c. Change the degree of flexibility
- d. Change the temperature
- e. Change the pressure



Use refrigerator to lower the temperature of food



Pressurize nitrogen gas into liquid for reduce volume while stored and transported in tanks

# Principle #36: Phase transitions

- a. Use phenomena occurring during phase transitions (e.g. volume changes, loss or absorption of heat)

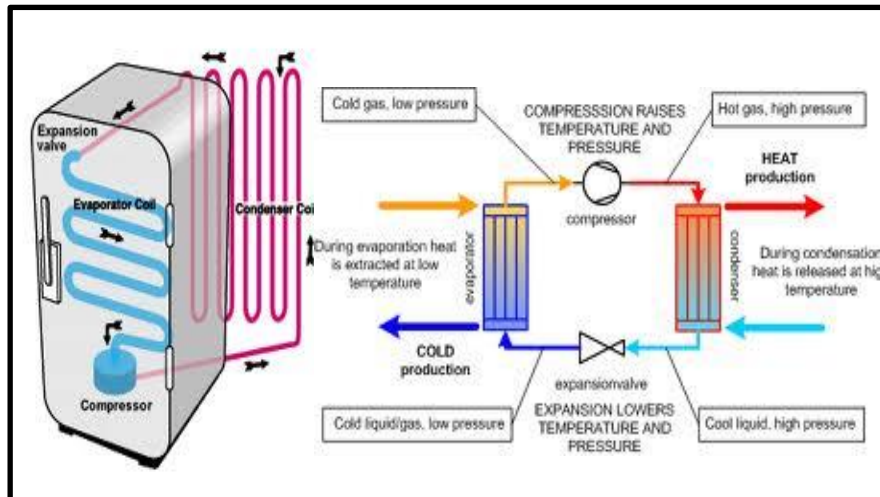

Refrigerator system uses concept of excess heat removal through heat of vaporization and condensation



Solid, liquid, gas e.g. dry ice from solid state to gaseous state

**Dry ice** blasting uses a pressurized air stream

# Principle #37: Thermal expansion

- a. Use thermal expansion (or contraction) of materials
- b. If thermal expansion is being used, use multiple materials with different coefficients of thermal expansion

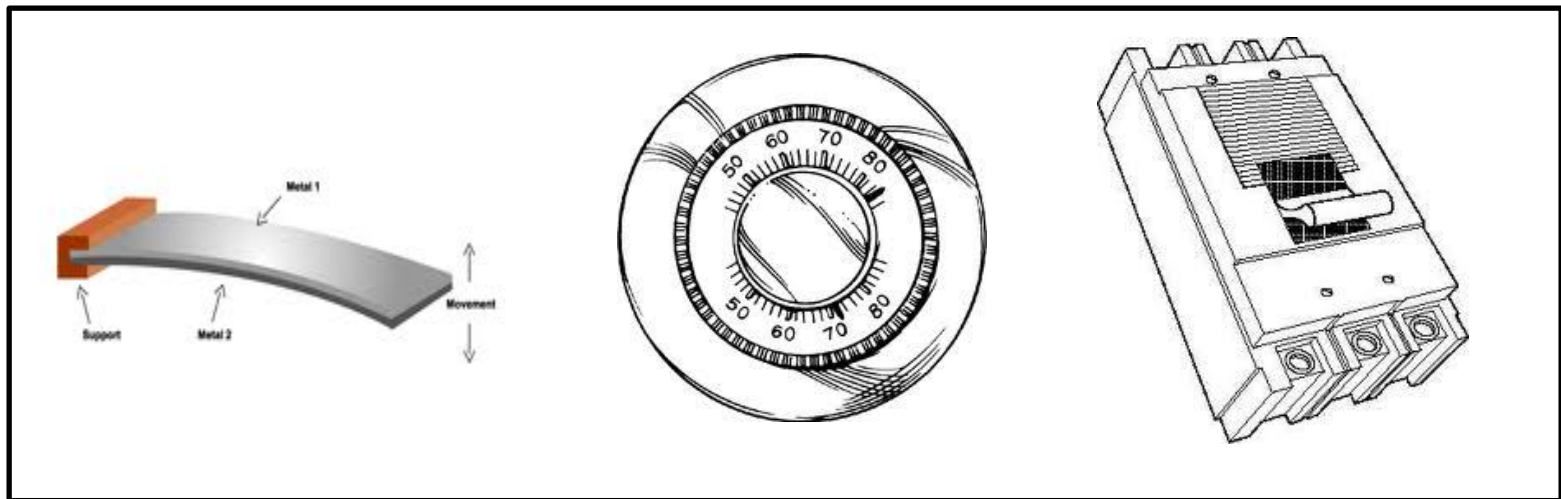

Bimetallic strip sensor

Thermostat

Circuit breaker

# Principle #38: Strong oxidants

- a. Replace common air with oxygen enriched air
- b. Replace enriched air with pure oxygen
- c. Expose air or oxygen to ionizing radiation
- d. Use ionized oxygen
- e. Replace ozonized (or ionized) oxygen with ozone



Use air ionizers to create a mixture of charged positive and negative air particles to reduce electrostatic charging



Use oxyacetylene torch for cutting at very high temperature

# Principle #39: Inert Atmosphere

- a. Replace a normal environment with an inert one
- b. Add neutral parts, or inert additives to an object



Nitrogen gas is used to fill up Formula 1 car tires to prevent loss of pressure during race. Nitrogen is an inert gas. Temperature has less effect on pressure.



Detergent or medicine has very little active material and this is difficult to weigh or measure. Inert substances are added to detergent or medicine to provide bulk and make it easier to weigh or measure.



# Principle #40: Composite materials

## a. Change from uniform to composite (multiple) materials

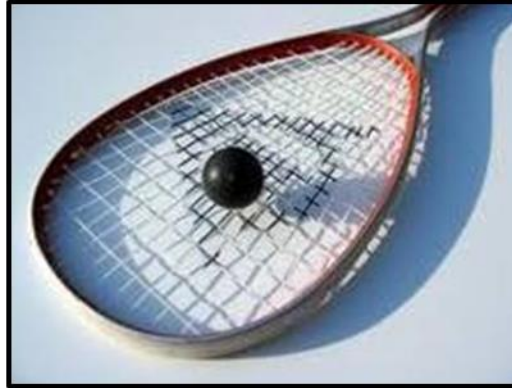

Most modern tennis racquet, golf club and bicycle shafts are made of either steel or a carbon-fiber and resin composite. Carbon fiber which is a composite material has the advantage of being lighter than steel.

# Inventive Principles – Exercise #4

Instructions:

Draw a line to match the pictures and the principles adopted

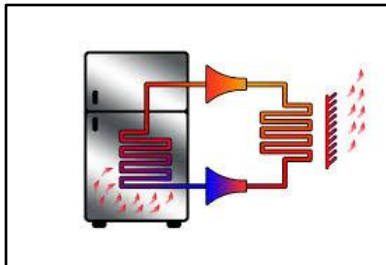

Porous materials  
Color changes  
Homogeneity

Discarding and recovering  
Parameter changes  
Phase transitions  
Thermal expansion  
Strong oxidants  
Inert atmosphere  
Composite materials



# Inventive Principles – Exercise #4

Instructions:

Draw a line to match the pictures and the principles adopted

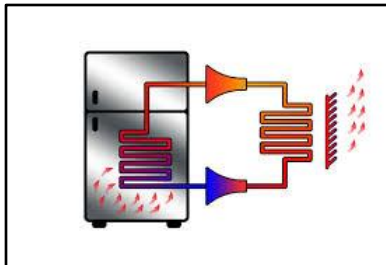

- Porous materials
- Color changes
- Homogeneity
- Discarding and recovering
- Parameter changes
- Phase transitions
- Thermal expansion
- Strong oxidants
- Inert atmosphere
- Composite materials



Contradiction Matrix & Application

# **MODULE 4**

# Contradiction Matrix

- The Inventive Principles are simple ways to resolve Engineering Contradictions – the application of the principles does not require any special knowledge. Adults as well as children can use them easily
- There are two methods to apply the Inventive Principles

## Method 1

Utilize the Contradiction Matrix in order to get a set of recommended Inventive Principles to solve the Engineering Contradiction. If no good solution, look at remaining 40 Inventive Principles

## Method 2



Familiarize with all 40 Inventive Principles and apply each or a combination to solve the Engineering Contradiction

- The Contradiction Matrix was designed to formalize and facilitate the usage of the Inventive Principles – it was one of the first outcomes of the work of Altshuller and his colleagues
- He abstracted and classified the Inventive Principles and also identified System Parameters that can describe all the different solved contradictions
- The System Parameters laid out in 39 x 39 matrix where the x-axis is the parameter that worsens, while the y-axis is the parameter that improves in the contradiction

# Contradiction Matrix

## 39 Worsening Parameters

39 Improving Parameters

Worsening Feature  Improving Feature 	Speed	Shape	Loss of Time	Reliability	Measurement accuracy	Ease of operation	Adaptability or versatility	System complexity	Measurement Difficulty	Productivity
Speed	+	35, 15, 18, 34		11, 35, 27, 28	28, 32, 1, 24	32, 28, 13, 12	15, 10, 26	10, 28, 4, 34	3, 34, 27, 16	
Shape	35, 15, 34, 18	+	14, 10, 34, 17	10, 40, 16	28, 32, 1	32, 15, 26	1, 15, 29	16, 29, 1, 28	15, 13, 39	17, 26, 34, 10
Loss of Information	26, 32		24, 26, 28, 32	10, 28, 23		27, 22			35, 33	13, 23, 15
Loss of Time		4, 10, 34, 17	+	10, 30, 4	24, 34, 28, 32	4, 28, 10, 34	35, 28	6, 29	18, 28, 32, 10	
Measurement accuracy	28, 13, 32, 24	6, 28, 32	24, 34, 28, 32	5, 11, 1, 23	+	1, 13, 17, 34	13, 35, 2	27, 35, 10, 34	26, 24, 32, 28	10, 34, 28, 32
Ease of operation	18, 13, 34	15, 34, 29, 28	4, 28, 10, 34	17, 27, 8, 40	25, 13, 2, 34	+	15, 34, 1, 16	32, 26, 12, 17		15, 1, 28
Ease of repair	34, 9	1, 13, 2, 4	32, 1, 10, 25	11, 10, 1, 16	10, 2, 13	1, 12, 26, 15	7, 1, 4, 16	35, 1, 15, 11		1, 32, 10
Adaptability or versatility	35, 10, 14	15, 37, 1, 8	35, 28	35, 13, 8, 24	35, 5, 1, 10	15, 34, 1, 16	+	15, 29, 37, 28	1	35, 28, 6, 37
System complexity	34, 10, 28	29, 13, 28, 15	6, 29	13, 35, 1	2, 26, 10, 34	27, 9, 26, 24	29, 15, 28, 37	+	15, 10, 37, 28	12, 17, 28
Productivity		14, 10, 34, 40		1, 35, 10, 38	1, 10, 34, 28	1, 28, 7, 10	1, 35, 28, 37	12, 17, 28, 24	35, 18, 27, 2	+